



MARQ's

New Innovations

Info@marq.net • 1-800-998-4301

NOTES:

1. R.H. SHOWN, L.H. OPPOSITE.
2. ALL DIMENSIONS ARE APPROXIMATE.

- AIR**
1. 80 PSI
- ELECTRICAL**
1. 110 VAC
 2. 1 PHASE
 3. CYCLE CONTROLS 60
 4. CONTROL VOLTAGE 110V

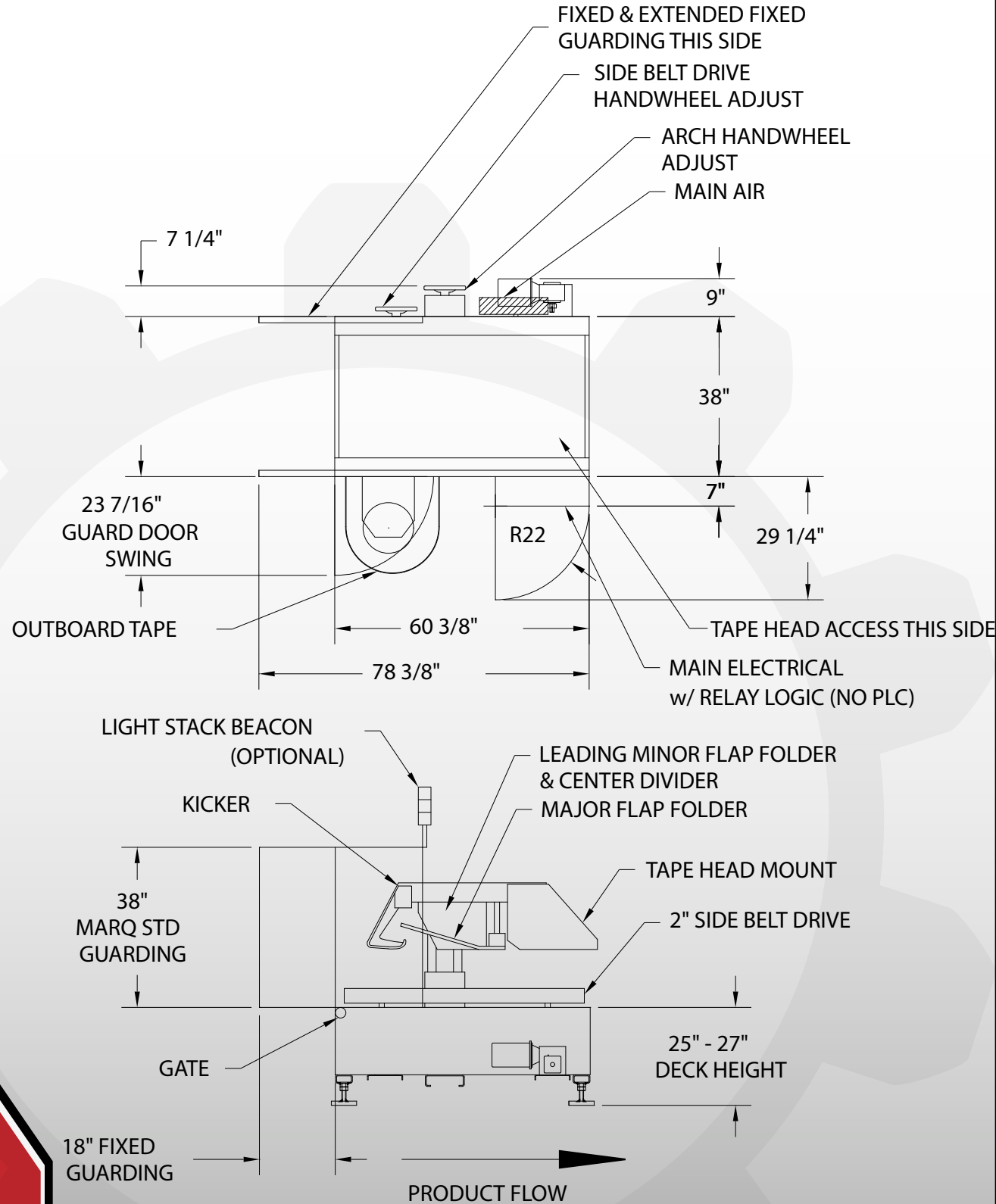

OWNERSHIP - PROPRIETARY DATA LEGEND

THIS DOCUMENT AND THE INFORMATION CONTAINED THEREIN IS THE PROPERTY OF MARQ PACKAGING SYSTEMS, INC. RECIPIENT AGREES NOT TO: (1) USE SUCH INFORMATION FOR PURPOSES OTHER THAN THOSE EXPRESSLY AUTHORIZED BY MARQ PACKAGING SYSTEMS, INC.; AND, (2) FURNISH SUCH INFORMATION TO ANY OTHER PERSON IN WHOLE OR IN PART FOR ANY PURPOSE WHATSOEVER, WITHOUT THE EXPRESS AUTHORIZATION OF MARQ PACKAGING SYSTEMS, INC. RECIPIENT ALSO AGREES NOT TO REPRODUCE OR COPY THIS DOCUMENT EITHER IN WHOLE OR IN PART WITHOUT THE PRIOR EXPRESS WRITTEN PERMISSION OF MARQ PACKAGING SYSTEMS, INC.; AND, TO PROMPTLY RETURN THIS DOCUMENT TO MARQ PACKAGING SYSTEMS, INC. UPON THE RECEIPT OF A WRITTEN REQUEST THEREFOR.

HPA-SBD-60-T-TB